



DS-1258ZJ

Wall mount for indoor cameras

Features:

- Good toughness and strength
- With wire outlet(s)
- Coordination with small and nice appearance

Dimension:

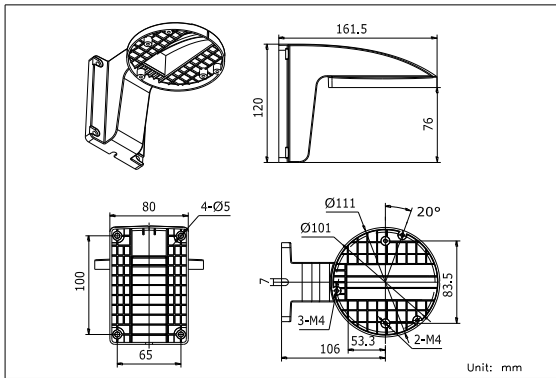

Order model:

DS-1258ZJ

Parameters

Model	DS-1258ZJ
Parameter's	Indoor wall mount
Color	Hik white
Feature	Suitable for mini dome or dome camera
Material	Plastic
Dimension	111 × 120 × 161.5 mm
Weight	113 g (0.25 lb.)

Notice:

- Pay attention to the application range when select bracket
- Pay attention to the color matching when select bracket
- The bracket should be installed on flat wall
- The wall must be capable of supporting more than 3 times the total load of the camera and the mount.
- The maximum load capacity of the mount is 2.0 kg

Installation steps:

- ① Select suitable wall to install the bracket and wire.

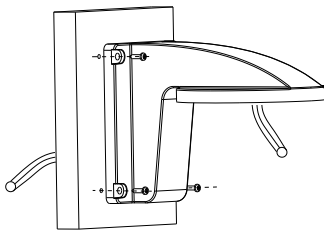

Notice: "A" stands for the lock screw

- ② Adjust the angle through the 3-axis adjustment structure.

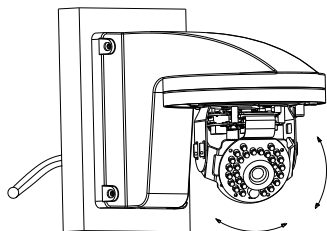

- ③ Loosen the tightening screw and take down the housing.

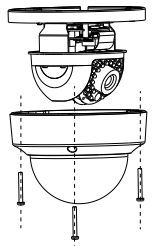

- ④ Install the housing and lock the screws.

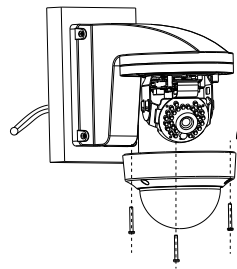

- ⑤ Install the dome core to the gang box, wire and lock the screw.

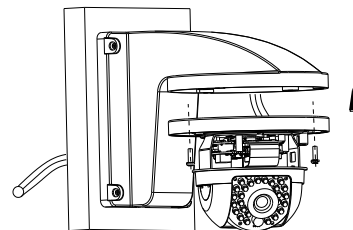

- ⑦ Finish the installation.

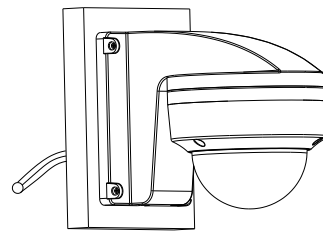

Remark: Appearance of Installation steps is for reference only