



## PVM32CAMLV Quick Guide



# Contents

Before You Begin.....	2
1. Packing List.....	3
2. Safety & Maintenance Instructions.....	3
3. Indicators and Interfaces.....	4
4. Connecting PVM Monitor.....	5
5. Initial Setup.....	6
IOT Product Activation.....	6
IP Network Activation.....	9
6. Other Settings.....	10
Set Time, Date and Network Settings.....	10
Uploading Company Logo.....	11
7. Password Recover.....	11

## Before You Begin

Please read this guide before installing or operating the product. You must have knowledge of CCTV, IT and electrical wiring and products.

### Technical Support

If you still have questions after referring to the guide, or require more information, please contact Vista Technical Support or use the QR code.

**Vista Technical Support +44 (0) 118 912 5125**

**Norbain SD, Inspired, Easthampstead Road, Bracknell, Berkshire RG12 1YQ**



\* WARNING: Improper use can cause severe bodily injury or equipment damage.

---

This guide is intended for use with the following product/s.

**PVM32CAMLV**

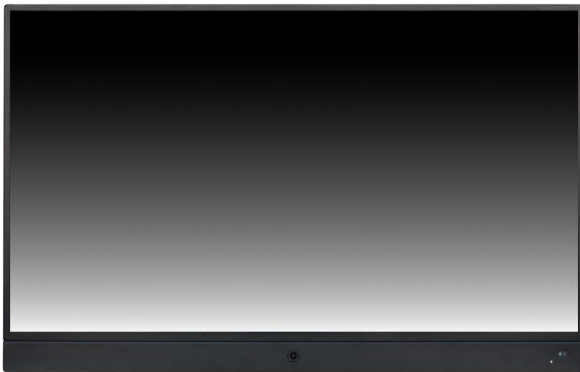

## 1. Packing List

Please contact Norbain if any items are missing or damaged.

- PVM Monitor
- Remote Control
- PSU adapter 100-240VAC to 24VDC 2.71A

## 2. Safety & Maintenance Instructions

- Use only the PSU supplied with the device or one of an identical rating.
- Do not use this apparatus near water.
- Do not install near any heat sources such as radiators, stoves, or other apparatus (including amplifiers) that product heat.
- Do not block any ventilation openings.
- Protect the power cord from being walked on or pinched.
- Only use attachments/accessories specified by the manufacturer.
- Unplug this apparatus during lightning storms.
- Refer all servicing to qualified service personnel only. Servicing is required when the apparatus has been damaged in any way, such as power-supply cord or plug is damaged, liquid spillage etc.



CAUTION - THESE SERVICING INSTRUCTIONS ARE FOR USE BY QUALIFIED SERVICE PERSONNEL ONLY. TO REDUCE THE RISK OF ELECTRIC SHOCK DO NOT PERFORM ANY SERVICING OTHER THAN THAT CONTAINED IN THE OPERATING INSTRUCTIONS UNLESS YOU ARE QUALIFIED TO DO SO.

### 3. Indicators and Interfaces

Refer below for description of indicators and interfaces.

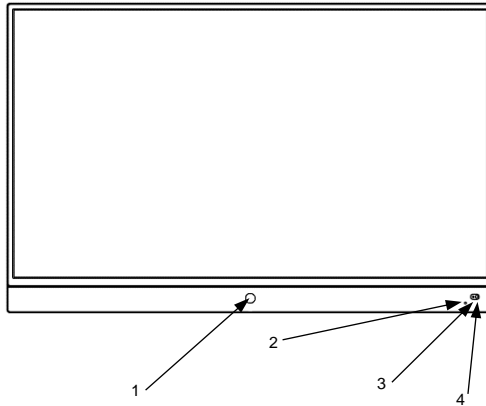

FRONT VIEW		
No.	Name	Function
1	Camera	Camera Lens
2	White LED	Configurable as an alert/deterrent
3	Blue LED	Indicates Power On (configurable on   off)
4	Remote IR	Remote Control Receiver

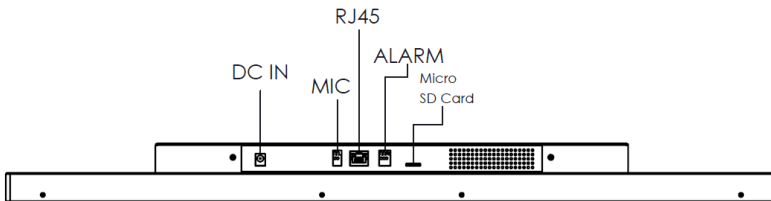

TOP REAR VIEW	
Name	Function
DC IN	24VDC input (2.71A) 2.5mm. Use adapter provided
MIC	Terminal (push fit) for external microphone
RJ45	Ethernet Port 10/100 (non-PoE)
ALARM	Terminal (push fit) for external alarm output
MicroSD CARD	MicroSD card slot (max 256GB)

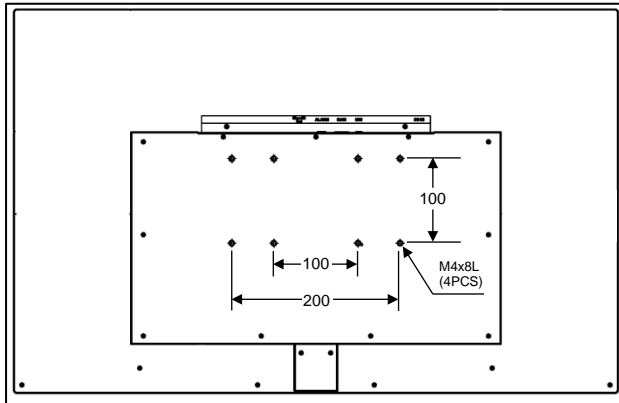

VESA 100x100 and VESA 200x100  
Rear view

## 4. Connecting PVM Monitor

Refer to the previous section and images for VESA dimensions as well as external interface connections and carry out the below.

1. Determine your VESA mounting requirements – whether wall-mounted or pole.
2. Fix the bracket or pole according to the relevant manufacturer's instructions ensuring adequate fixings are used for the surface being fixed to and the load.
3. Fix the PVM monitor to the VESA 100x100 or 200x100 bracket, making note of the maximum length of the screws according to the rear PVM image above.
4. Connect any required alarm or microphone inputs. Strip insulation from ends of the wires, then using a small flat-screwdriver, "open" each terminal, insert wire and release. Pull to test the connection!
5. Connect an Ethernet cable if connectivity to a network is required.
6. Plug in the 2.5mm plug of the supplied AC adapter into the DC IN. Then connect the adapter to an AC supply to boot-up.

## 5. Initial Setup

If your PVM displays the IOT Security screen (right) when first powering up, it requires activation by first setting its admin account with your own strong password before it becomes fully operational.

As part of new Product Security standards, this activation feature is introduced as of April 2024 and firmware versions that are later than 1.0.0.50.

Continue to read this section for guidance on activating your PVM first.

However, if your PVM displays a live image instead on powering up, then either your PVM predates IOT firmware or your PVM may have been provided via the Norbain Pre-build Team and setup with relevant passwords for you already. In such a case, please go to section 6. **Other Settings** instead.

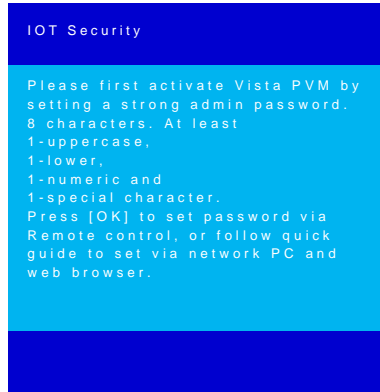

## IOT Product Activation

Until successfully activated, the PVM will:

- Not display a live local image on its screen.
- Not be accessible via ONVIF from NVR recorders.
- Not stream video over Ethernet.

There are two simple methods to activate the PVM, according to your application.

	Method	Best For Activating
Local	Via the IR remote	Small number of PVMs
IP network	Via laptop and Discovery software download	Larger number & setting IP addresses

Once activated, there is no need to re-enter your strong password locally each time – only necessary when accessing the web page or adding the PVM to an NVR.

---

**Note the requirements of a strong password on the screen below as you proceed!**

---

If activating via IP network and laptop, go to the **IP Network Activation** section instead.

- Press **[OK]** button, the “Change Password” screen will be shown (below-right).

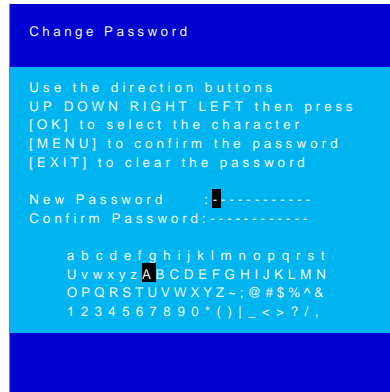
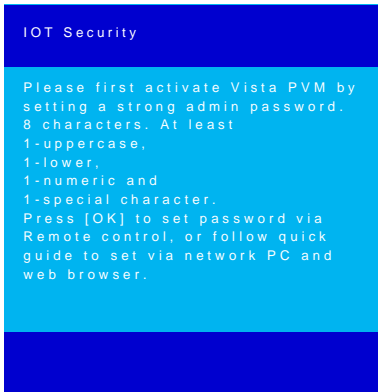

- Using direction buttons on the remote control (right), move to and highlight, each character and press **[OK]** to select.
- Repeat to enter 8-character password minimum, press **[MENU]**

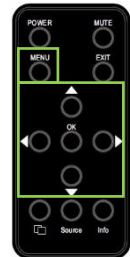

---

**Note: if needing to delete a character, press [EXIT] to start again.**

---

If “Unsuccessful Password Entry!” screen is shown (below), password is not strong enough. Press either **[OK]** to go back and add more characters, or **[EXIT]** to go back and delete all characters and start again.

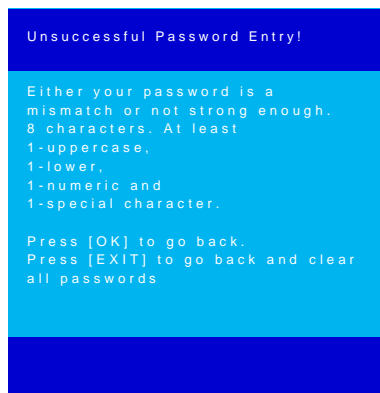



- Once strong password is entered - pressing **[MENU]** moves cursor to the “Confirm Password” line. Re-enter the password and press **[MENU]** to complete.
- If “Unsuccessful Password Entry!” screen is displayed – you mistyped the confirmation. Press **[OK]** to re-enter it, or **[EXIT]** to erase all passwords and start again.
- Once password is confirmed, the “Successful Password Entry” screen displays and the PVM reboots.

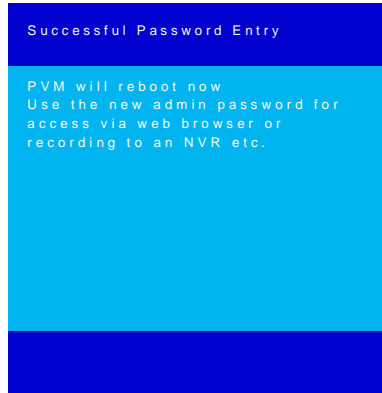

- Once rebooted, continue to configure the PVM as required. Use the new password for web access or to record the PVM to an NVR.

This completes the procedure. Go to section **6. Other Settings**

## IP Network Activation

- First, install the Discovery Tool software to your laptop (below).

- Visit url [www.vista-cctv.com](http://www.vista-cctv.com).
- Click navigation bar and links **Support > Downloads > Vista IP**
- Click folders **[PVM10CAMxx Range] > [PVM10CAMs] > [Software] > [Discovery Tool]**

Click and download the latest version of the .zip file, unzip and install.

- Connect laptop to the same Ethernet LAN/VLAN as the PVMs.
- Open Device Installer – screen displays all PVMs on the same network.
- Double-click anywhere on required PVM to open its web page (below).

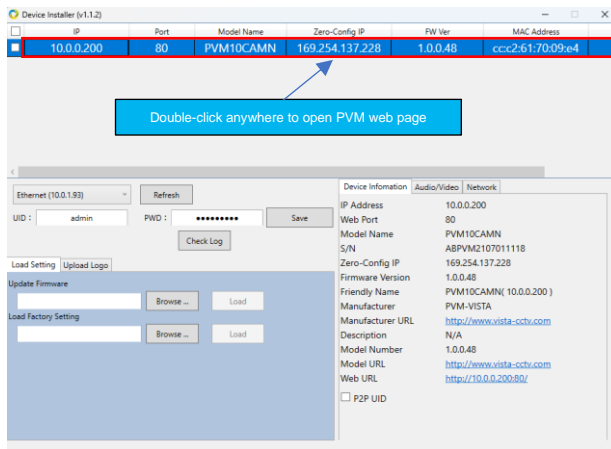

- Enter install password. Ensure you receive the “Successful” prompt.
- The PVM will reboot after 5-seconds and be activated.

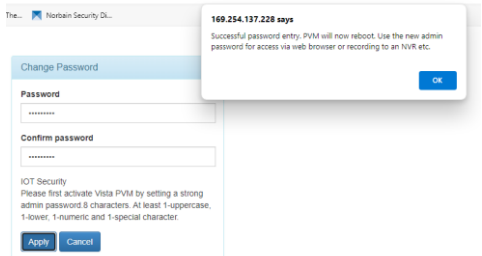

This completes the procedure. Go to section **6. Other Settings**

## 6. Other Settings

Enter the PVMs menus to configure any required features or settings below. Use the remote control (right) and use the [menu] button, the **arrow** and [OK] buttons to navigate and select.

### CONFIGURABLE FEATURES

- Date & Time
- Network - DHCP | static
- Camera orientation - bottom | top
- Blue/white LED - on | off
- Tamper alarm - on | off
- Motion detection - duration | sensitivity
- Text Message - on | off
- Select text message - 1 | 2 | 3
- Logo display\* - Off | Logo | seq1 | seq2\*
- Logo to display\* - 1 | 2 | 3 | 4 | 5\*
- Audio Alert - off | 1 | 2 | 3

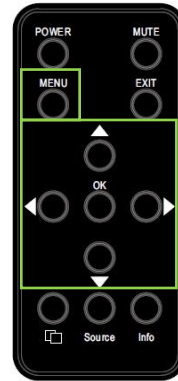

---

***\*To upload and display your own company logos, refer to section titled  
UPLOADING COMPANY LOGO***

---

## Set Time, Date and Network Settings

1. Press [MENU]
2. Use down arrow key, go to **Setup Menu** (right) press [OK]
3. Down arrow key to **Camera Setting**, press [OK]
4. Press [OK] on **Date & Time Setting** menu (below right)
5. Select either **Date** or **Time** to amend, press [OK]
6. Use <> arrow keys; navigate to each digit in turn that needs changing, use up and down key to change the value.
7. Press [OK] once completed to set.
8. Navigate down to **Exit** and press [OK] save the change!
9. Press down arrow, select **Network Setting** and press [OK]. Set either DHCP or a static IP address as required.
10. Make sure to select [EXIT] and press [OK] to save!

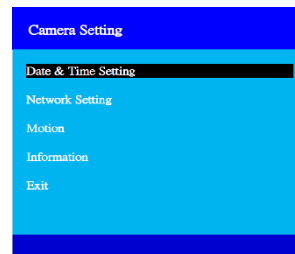

***Note: To save any menu changes, you must select the menus EXIT option at the bottom of the screen and press [OK]! After saving settings, you can then repeatedly press the [EXIT] key to exit each menu in turn.***

11. The remaining PVM options and features mentioned are configurable by selecting the following menus in turn **Main Menu > PVM Function** (below).

PVM Function		
Display Message		ON
Warning Message		1
Logo Display Mode		Logo
Logo Select		2
Sequence Dwell		5
Audio Alert		1
Exit		

## Uploading Company Logo

The PVM can be set to switch from displaying its “Live” image, to your company's logo instead, while no motion is detected. You can have up to five logos and they must meet the below parameters and be uploaded to the PVM first via Ethernet and laptop PC with a web browser.

### PVM LOGO PARAMETERS

- JPEG image of resolution 1080 x 1920 Portrait or 1920 x 1080 Landscape.
- File size less than 1.5MB

Logo Setting

Logo file 1	<input type="button" value="Choose File"/> No file chosen	<input type="button" value="Upload"/>
Logo file 2	<input type="button" value="Choose File"/> No file chosen	<input type="button" value="Upload"/>
Logo file 3	<input type="button" value="Choose File"/> No file chosen	<input type="button" value="Upload"/>
Logo file 4	<input type="button" value="Choose File"/> No file chosen	<input type="button" value="Upload"/>
Logo file 5	<input type="button" value="Choose File"/> No file chosen	<input type="button" value="Upload"/>

Click and follow the below link for detailed PVM Logo Upload instructions;

[Vista PVM10CAMx Logo Upload](#)

## 7. Password Recover

Should you lose your password, simply use the remote control, press **[MENU]** and select **[Restore Defaults]**. Then Reactivate the PVM.



Where applicable, a Declaration of Conformity in accordance with Directives 2014/30/EU (EMC), 2014/35/EU (LVD), and 2015/863/EU RoHS (3) has been made and we declare the product compliant.

**RoHS**  
COMPLIANT

Where applicable, the requirements of the European law on the Restriction of Hazardous Substances (RoHS) directive: 2015/863/EU have been met and the product is without the hazardous substances cited in the directive.

**Our CE EU-Authorised Representative: Comply Express Unipessoal LDA, StartUp Madeira - EV141, Campus da Penteadá, 9020-105 Funchal, Madeira, Portugal".**



Symbolizes that within the European Union the product must be collected separately at the product end-of-life. Do not dispose of these products as unsorted municipal waste.

#### WARNING

This is a Class A product. In a domestic environment this product may cause radio interference in which case the user may be required to take adequate measures.

No liability will be accepted by Vista for any errors or omissions in this information and reserves the right to make changes to the product and its specification from time to time without prior notice.

Page intentionally left blank

Page intentionally left blank

Page intentionally left blank