



Easy migration from analog to IP system with existing coaxial cable

Key Features

Two models (4-channel and 1-channel) are provided on the receiver side
Up to 4 network cameras can be connected and used on a single receiver side unit. (WJ-PR204)

Power over Ethernet Plus (PoE+) ready

The coaxial - LAN converter is compliant with PoE+ standards (IEEE802.3at) and PoE+ cameras can be connected and used*1.

Use over long distances (WJ-PR201)

The coaxial - LAN converter can be used for distances of up to 300 m (984 feet) for PoE+ connections and 500 m (1,640 feet) for PoE connections, and 2.0 km (6,560 feet) for non-PoE+ connections. (When used with RG-6/U coaxial cable, and the loop resistance is below 4 W/100 m {328 feet} without additional joint parts.)

High-speed transmission

The coaxial - LAN converter is capable of transmission speeds of 35 Mbps or over for TCP*2, and 45 Mbps or over for UDP connections*2. (When used with RG-6/U coaxial cable, and for distances under 2.0 km (6,560 feet) <PR201>, 500 m (1,640 feet) <PR204>.)

No setup required

Connections can be established by simply connecting the coaxial cable to the coaxial - LAN converter.

*1 There are limitations on the combinations of the cameras to be connected, the type of power supply and transmission range to the receiver side units. For more detail please see the operating instructions on our website (<http://security.panasonic.com/pss/security/support/>).

*2 Transmission speed is the speed of transmission between the receiver side unit and the camera side unit. Values may vary depending on the condition of the coaxial cable (for example, as the cable deteriorates overtime), network conditions, etc.

Standard Accessories

WJ-PR204 / WJ-PR201

- Operating Instructions 1 pc.
- AC adapter 1 pc.
- AC Cord 1 pc. (WJ-PR204, WJ-PR201)
- 2 pcs.¹ (WJ-PR204E, WJ-PR201E)
- BNC Connector Cover (4 ch) (WJ-PR204) 1 pcs.
- BNC Connector Cover cap (WJ-PR204) 3 pcs.²
- BNC Connector Cover (1 ch) (WJ-PR201) 1 pc.
- Screw (M2.6 x 10 mm {3/8 inches}) 2 pcs. of them, 1 for spare.

WJ-PC200

- Operating Instructions 1 pc.
- BNC Connector Cover (1 ch) 1 pc.
- Wood screw (4 x 20 mm {13/16 inches}) 3 pcs. of them, 1 for spare.
- Screw (M2.6 x 10 mm {3/8 inches}) 2 pcs. of them, 1 for spare.² pcs.
- PoE incompatible cable 1 pc.
- Cable coupler (used with the network cable) 1 pc.

*1 UK and other types of AC cords are included.

*2 BNC Connector Cover cap will be shipped with attached to the BNC connector cover of 4ch.

Optional Accessory

Rack Mount Connecting Fitting

BY-HCA10A

(for mounting three or four Receiver side unit)

- For U.S. and Canada : BY-HCA10A
- For Europe and other countries : BY-HCA10CE



- Mounting Bracket 2 pcs.
- Underside Continuous Connecting Bracket 2 pcs.
- Screw (Flat-head M3 x 6 mm{1/4 inches}) 32 pcs.
- Screw (M3 x 6 mm{1/4 inches}) 6 pcs.

System Example

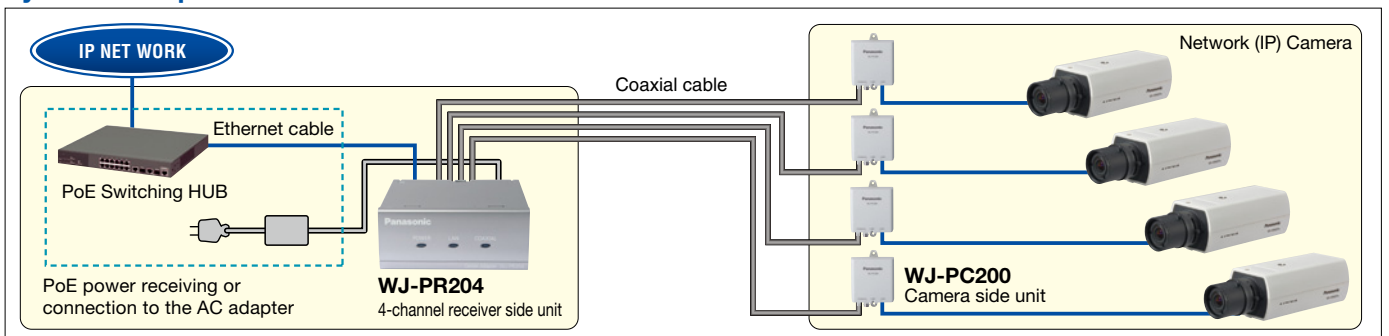

Specifications

Receiver side unit

Items	Specifications
Operating Environment	Temperature : 0 to 50 °C (+32 °F to +122 °F) Humidity : 10 % to 90 % (without condensation)
Interfaces	10Base-T/100Base-TX x 1 BNC connector : x 4 (WJ-PR204), x 1 (WJ-PR201)
Dimensions (W x H x D) (approx.)	Main Body : 105 mm x 44 mm x 98 mm {4-5/32 inches x 1-3/4 inches x 3-7/8 inches} When a BNC connector cover is mounted : 105 mm x 44 mm x 165 mm {4-5/32 inches x 1-3/4 inches x 6-1/2 inches}
Mass (approx.)	WJ-PR204 : 270g (0.6 lbs) WJ-PR201 : 250g (0.55 lbs)
Power Supply	Use the included AC adapter. INPUT : 100 - 240 V 50/60 Hz OUTPUT : DC 57 V / 1.14 A Use the PoE power supply PoE DC 48V / Approx. 265 mA
Power Consumption	Use the included AC adapter. WJ-PR204 : DC 57 V / 1.14 A / Approx. 65 W WJ-PR201 : DC 57 V / 700 mA / Approx. 40 W Use the PoE power supply PoE DC 48 V : 265 mA / Approx. 12.95 W (Class 0 device)
Finish	Main unit : PC/ABS Silver, BNC connector cover : PC/ABS Grey (WJ-PR204), ABS White (WJ-PR201)

Camera side unit

Items	Specifications
Operating Environment	Temperature : -10 to 50 °C (+14 °F to +122 °F) Humidity : 10 % to 90 % (without condensation)
Interfaces	10Base-T/100Base-TX x 1 BNC connector x 1
Dimensions (W x H x D) (approx.)	Main Body : 76 mm x 76 mm x 36 mm {3 inches x 3 inches x 1-7/16 inches} When a BNC connector cover is mounted : 76 mm x 156 mm x 36 mm {3 inches x 6-5/32 inches x 1-7/16 inches}
Mass (approx.)	110 g (0.24 lbs)
Power Supply	Original power system (from the receiver side unit via the coaxial cable)
Finish	Main unit : PC/ABS Sail white BNC connector cover (1 ch) : ABS White

Performance Specifications

Items	Specifications
Transmission Speed ^{*1} (When the AC adapter(accessory) is used)	UDP : 45 Mbps or higher ; TCP ^{*2} : 35 Mbps or higher (when using an RG-6/U coaxial cable at distances under 500 m (1,640 feet) <PR204>) (when using an RG-6/U coaxial cable at distances under 2.0 km (6,560 feet) <PR201>)
Maximum Transmission Distance of a Coaxial Cable (When the AC adapter (accessory) is used)	200 m (656 feet) : PoE+ camera ⁴ 300 m (984 feet) : PoE+ camera recommended by Panasonic ^{3,4} 300 m (984 feet) : PoE camera 500 m (1,640 feet) : PoE camera recommended by Panasonic ³ 500 m (1,640 feet) : Camera powered by an external power supply <PR204> 2.0 km (6,560 feet) : Camera powered by an external power supply <PR201>

^{*1} This value is the total value of the transmission speed between the receiver side and camera side unit.

The transmission speed when using an RG-6/U coaxial cable may vary depending on factors such as the coaxial cable condition and network environment.
The values shown here measured in environments not affected by cable or network environment conditions.

^{*2} Measured using Linux® FTP.

^{*3} For information about the cameras recommended by Panasonic to be used for the camera side unit, visit our web site. (<http://security.panasonic.com/pss/security/support/info.html>)

^{*4} The maximum length of an Ethernet cable used to connect a PoE+ camera is 50 m (164 feet).

Connection types and power supply to receiver side units

(1) When using a 1-channel Receiver side unit

Receiver side unit power source	Camera power source	Camera side unit Ethernet cable length (1)	Receiver side unit Ethernet cable length (2)	Compatible coaxial cable length(3)
AC adapter	PoE+	Max. 50 m {164 feet}	Max. 100 m {328 feet}	Max. 200 m {656 feet} : PoE+ camera Max. 300 m {984 feet} : Cameras recommended by Panasonic ^{*1}
	PoE	Max. 100 m {328 feet}	Max. 100 m {328 feet}	Max. 300 m {984 feet} : PoE camera Max. 500 m {1,640 feet} : Cameras recommended by Panasonic ^{*1}
	External power supply	Max. 100 m {328 feet} ^{*3}	Max. 100 m {328 feet}	Max. 2.0 km {6,560 feet}
PoE	PoE+	Cannot be connected	Cannot be connected	Cannot be connected
	PoE ^{*2}	Max. 100 m {328 feet}	Max. 5 m {16 feet 4-27/32 inches}	Max. 300 m {984 feet} : PoE camera Max. 500 m {1,640 feet} : Cameras recommended by Panasonic ^{*1}
	External power supply	Max. 100 m {328 feet} ^{*3}	Max. 5 m {16 feet 4-27/32 inches}	Max. 2.0 km {6,560 feet}

(2) When using a 4-channel Receiver side unit

Receiver side unit power source	Camera power source	Camera side unit Ethernet cable length (1)	Receiver side unit Ethernet cable length (2)	Compatible coaxial cable length(3)
AC adapter	PoE+	Max. 50 m {164 feet}	Max. 100 m {328 feet}	Max. 200 m {656 feet} : PoE+ camera Max. 300 m {984 feet} : Cameras recommended by Panasonic ^{*1}
	PoE	Max. 100 m {328 feet}	Max. 100 m {328 feet}	Max. 300 m {984 feet} : PoE camera Max. 500 m {1,640 feet} : Cameras recommended by Panasonic ^{*1}
	External power supply	Max. 100 m {328 feet} ^{*3}	Max. 100 m {328 feet}	Max. 500 m {1,640 feet}
PoE	PoE+	Cannot be connected	Cannot be connected	Cannot be connected
	PoE ^{*2}	Cannot be connected	Cannot be connected	Cannot be connected
	External power supply	Max. 100 m {328 feet} ^{*3}	Max. 5 m {16 feet 4-27/32 inches}	Max. 500 m {1,640 feet}

^{*1} For information about network cameras recommended by Panasonic, visit our web site. (<http://security.panasonic.com/pss/security/support/info.html>)

^{*2} Use a PoE camera that consumes no more than 6.5 W.

^{*3} When connecting a PoE camera or PoE+ camera to an external power supply, make sure to use the included PoE incompatible cable.

When the camera side unit can be installed near the camera, connect the PoE incompatible cable directly to the camera.

When the camera side unit is installed far from the camera, use the included cable coupler.

When a PoE incompatible cable is used, power is not supplied to the camera.

Coaxial Interface

Items	Specifications
Standard	Panasonic original system
Frequency Range	2 MHz-28 MHz
Data Transfer Mode	Wavelet OFDM
Access Method	CSMA/CA
Error Correction	Reed-Solomon Code + Convolutional Code (Viterbi decoding)

LAN Interface

Items	Specifications
Standard	IEEE802.3/IEEE802.3u (10Base-T/100Base-TX)
MDI/MDI-X	Cross/Straight cable automatic recognition
Transmission Rate	10 Mbps/100 Mbps (Auto-Sensing)
Number of Ports	1 (RJ45 connector)
Protocol	TCP/IP, UDP
Access Method	CSMA/CD

Connection Specifications

Items	Specifications
Number of units that can be communicated with	WJ-PR204 : Up to 4 Camera side units can be connected. ¹ WJ-PR201 : 1 Camera side unit can be connected.
Connectable Devices	Receiver side unit : devices equipped with 10Base-T/100Base-TX interfaces Camera side unit : PoE camera, PoE+ camera, or camera driven by external power ²
Number of devices that can be connected	A maximum of 128 receiver side unit or camera side unit can be connected in 1 segment

^{*1} There are restrictions regarding combining cameras.

For more detail please see the operating instructions on our website.
(<http://security.panasonic.com/pss/security/support/>)

^{*2} The maximum distance that can be connected with a coaxial cable varies depending on the camera used.

For more detail please see the operating instructions on our website.
(<http://security.panasonic.com/pss/security/support/>)

Maintenance Screen Specifications

Items	Specifications
Compatible Operating Systems	Microsoft® Windows® 8.1, Microsoft® Windows® 8 Microsoft® Windows® 7, Microsoft® Windows Vista®
Web Browser	Windows® Internet Explorer® 11 32 bit Windows® Internet Explorer® 10 32 bit Windows® Internet Explorer® 9 32 bit Windows® Internet Explorer® 8 32 bit Windows® Internet Explorer® 7 32 bit

Part Names and Functions

WJ-PR201/WJ-PR204 (connects to the network device)

Front View

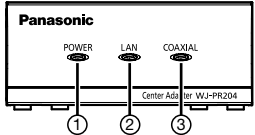

① Power Indicator
② LAN Indicator
③ COAXIAL Indicator

Rear View

4-channel

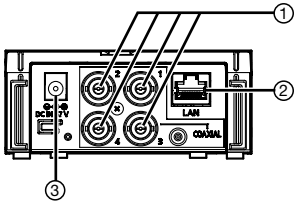

① BNC connector
② Network connector
③ DC IN

1-channel

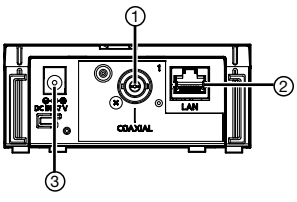

① BNC connector
② Network connector
③ DC IN

WJ-PC200 (connects to the camera)

Front View

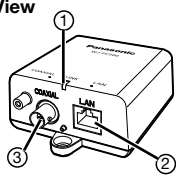

① LINK Indicator
② Network connector
③ BNC connector

Rear View

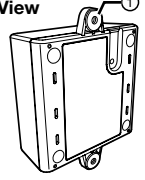

① Used when attaching the camera side unit to a ceiling or wall with screws.

Appearance

WJ-PR204 / WJ-PR201 (The illustrations are WJ-PR204.)

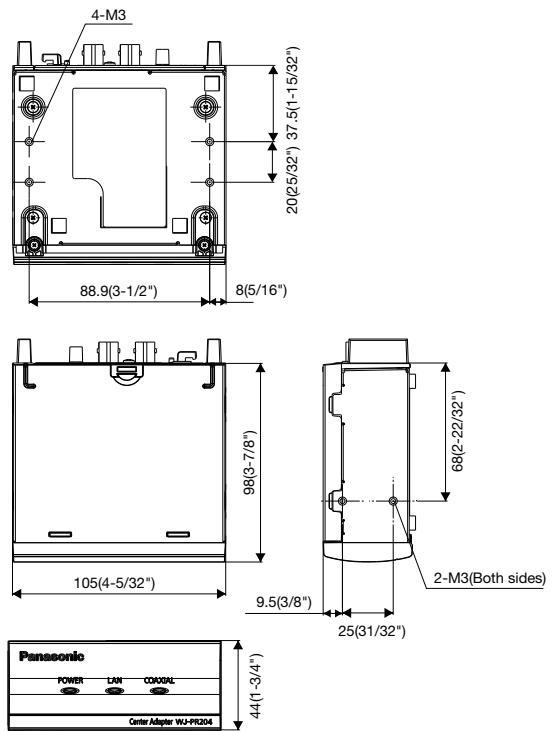

WJ-PC200

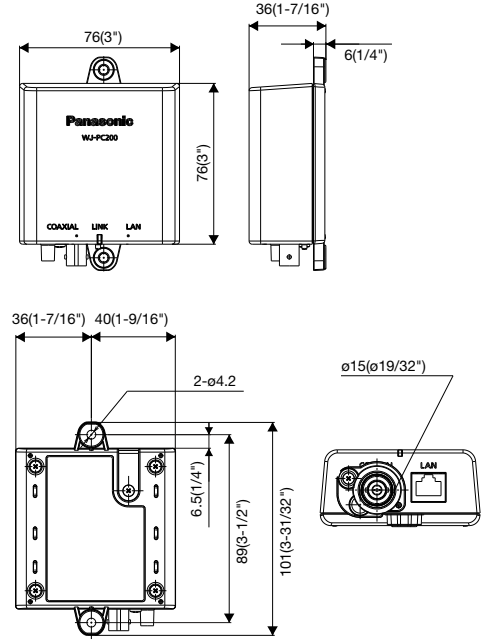

Unit: mm (inches)

Trademarks and registered trademarks

- Microsoft, Windows, Windows Vista, Windows Media, Internet Explorer, and ActiveX are either registered trademarks or trademarks of Microsoft Corporation in the United States and/or other countries.
- Microsoft product screen shot(s) reprinted with permission from Microsoft Corporation.
- Linux is a registered trademark of Linus Torvalds in the United States, and/or other countries.
- "i-PRO SmartHD" logo is trademarks or registered trademarks of Panasonic Corporation.

Important

- Safety Precaution: Carefully read the operating instructions before using this product.
- Panasonic cannot be responsible for the performance of the network and/or other manufacturers' products used on the network.

- Masses and dimensions are approximate.
- Specifications are subject to change without notice.

DISTRIBUTED BY:

Panasonic

<http://security.panasonic.com>

 <http://www.facebook.com/PanasonicNetworkCamera>

(2A-162CA)